

# Customer-specific solutions

Customized products for device manufacturers

# Customer-specific solutions

You have specific requirements and require a new development tailored to your requests? We support you with implementing your product, providing our expertise from the areas of development, production and quality assurance. We rely on our proven product technology as well as our development processes that have proven their worth for many years. This allows us to provide you with all required services for your new product.

## Your advantages

- ✓ Connection technology in your preferred design
- ✓ Development, qualification and certification from a single source
- ✓ Simultaneous engineering of items and production
- ✓ Early delivery of prototypes
- ✓ Full support from product launch to discontinuation

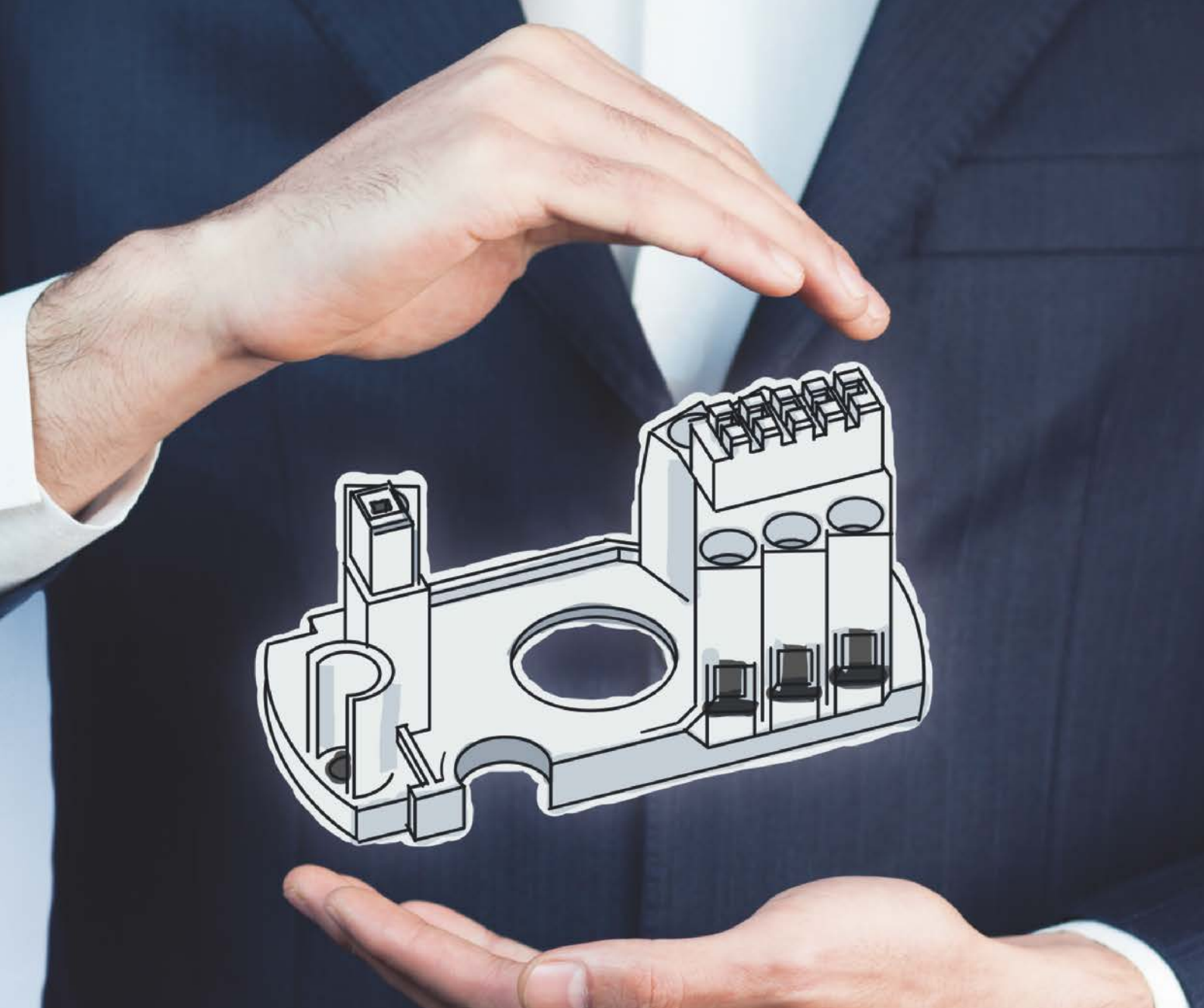

### Energy connector systems

Our connection technology in your design for the ideal transmission of signals, data or power.



### IP67 outdoor systems

Concepts for a long service life for outdoor use or in harsh industrial environments.

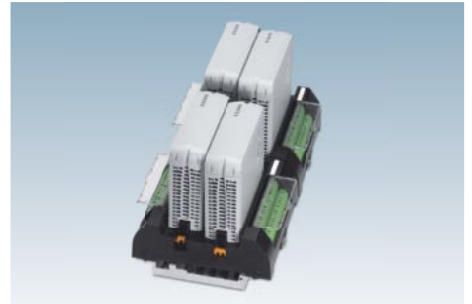

### IP20 housing systems

Your technology in our housing systems, designed accurate in every detail according to your design specifications and including the suitable connection technology.



# Efficient and proven development

When you receive a customized product from us, it has gone through a development process that is quality-assured and proven extensively. The process goes from your inquiry to concept development through to the production and delivery. Trust in the expertise of a market-leading manufacturer of electronics housings, connectors and PCB connection technology. We are always close to you by accessing our worldwide network of sales, development and production sites.



## Concept development

We work together with you to find the requirements for your product. We address challenges early on and guarantee an efficient development.



## Design

Following the preliminary clarification, the design and implementation of prototypes gets underway. The knowledge from prototyping is incorporated into the later solution.



## Production installation design

We use our global network to find the location for your requirements. You get the highest product quality thanks to ideal manufacturing performance.

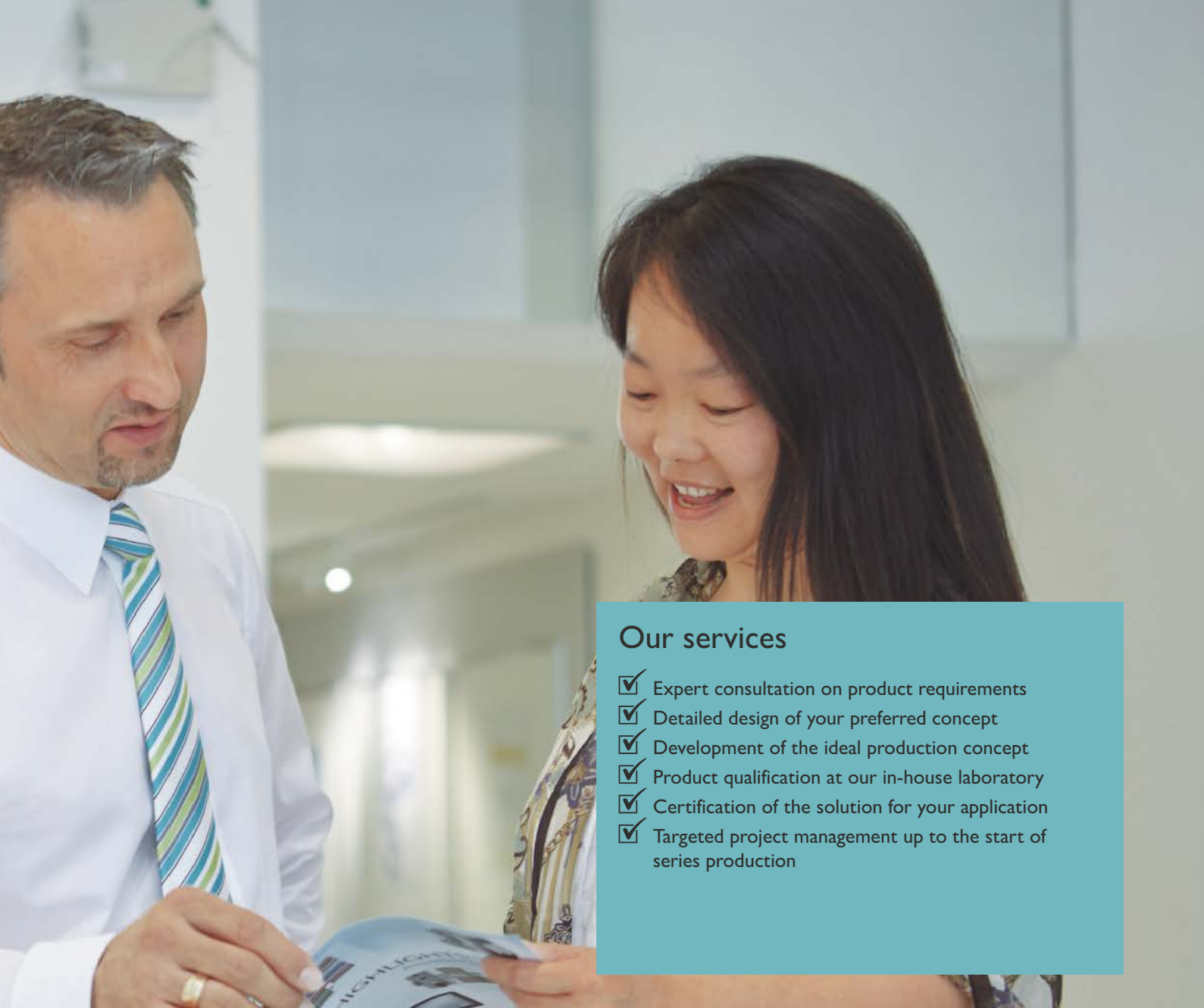

## Our services

- ✓ Expert consultation on product requirements
- ✓ Detailed design of your preferred concept
- ✓ Development of the ideal production concept
- ✓ Product qualification at our in-house laboratory
- ✓ Certification of the solution for your application
- ✓ Targeted project management up to the start of series production



### Quality assurance

We carefully test your product in all manufacturing phases. We ensure this with intensive testing before the series release and with production-related checks.



### Series production

We produce your products according to your requirements and the latest quality standards. Series production is lucrative for you even for low quantities.



### Logistics

Efficient logistics for your satisfaction: We deliver the finished product to you on schedule and according to your wishes.



# Profound expert knowledge in all project phases

Our philosophy is to master and develop all development, manufacturing and assembly processes. This helps us to guarantee a consistently high quality and delivery reliability. Take advantage of our years of expertise. Whether it's power transmission, protected solutions for outdoor use or industrial housings in your desired design – we offer you a product design developed specifically for your needs.

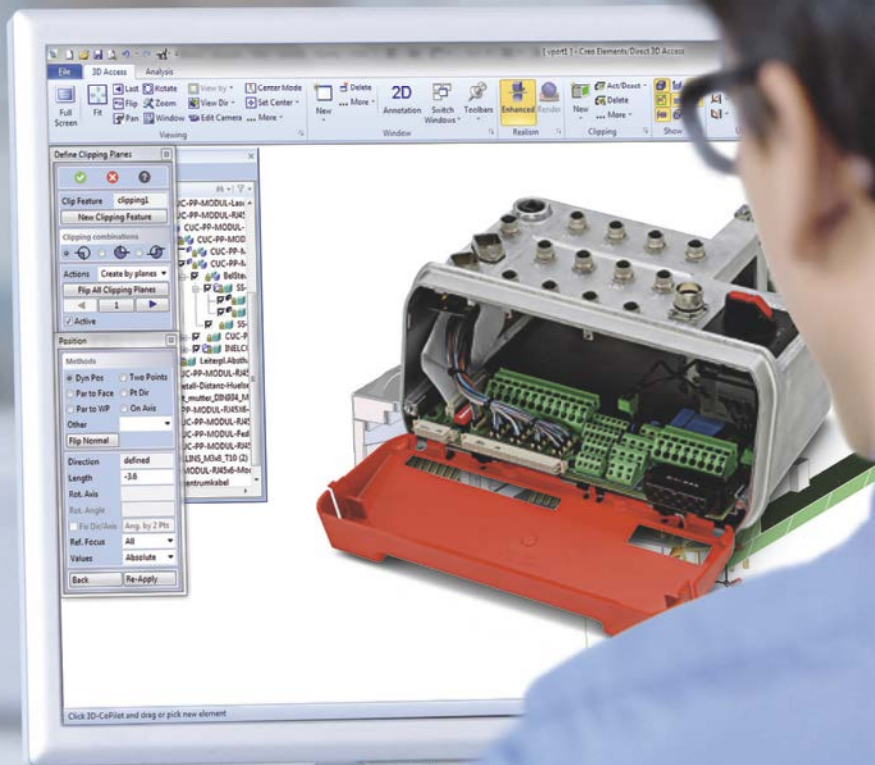



## Our main areas of expertise at a glance



### Connection technologies

Solid or stranded conductors, large or small cross sections, with or without ferrule: We have the solution for every requirement.

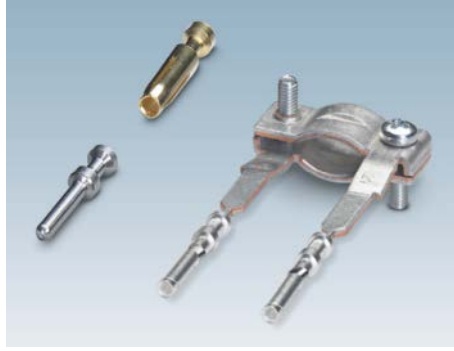

### Contact technology

Whether it's for signals, data, high power or the use in harsh environments – we have the right contacts.



### Metal housings, die-casting technology

Metal housings are convincing in industrial applications with their robustness and excellent shielding.

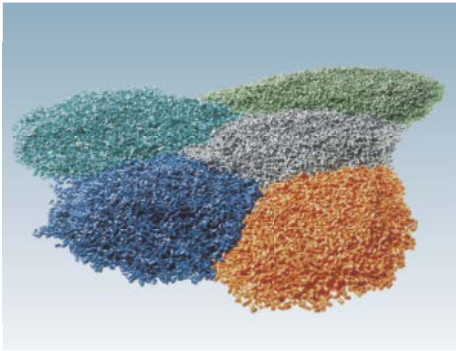

### Plastics technology

Choose from a large variety of plastic materials and colors. We assist you with the selection of the plastic.



### Injection-molding production

Our injection-molding technology offers you nearly limitless design options for surfaces. Even small quantities are lucrative for you.



### IP protection

Whether it's molded solutions or molds for outdoor applications: Our seal systems also meet high degrees of protection.

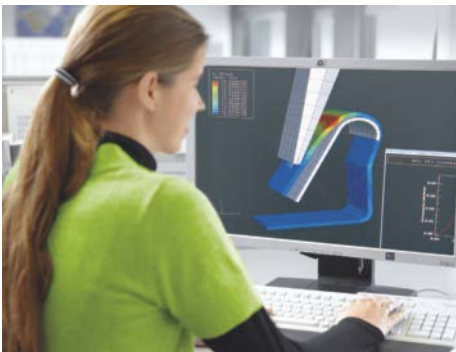

### Simulation

State-of-the-art simulation methods provide us with an insight and understanding right down to the smallest detail. We already test your product intensively early on.



### Prototype construction

We deliver prototypes up to a 100 percent completion – including additive manufacturing with 3D printing from Protiq GmbH.



### Certifications

International approvals and certificates, including the UL standard, attest to the suitability of our products.

## In dialog with customers and partners worldwide

Phoenix Contact is a globally present, Germany-based market leader. Our group is synonym for future-oriented components, systems, and solutions in the fields of electrical engineering, electronics, and automation. A global network across more than 100 countries, and 15,000 employees ensure a close proximity to our customers, which we believe is particularly important.

The wide variety of our innovative products makes it easy for our customers to find future-oriented solutions for different applications and industries. We especially focus on the fields of energy, infrastructure, process and factory automation.



You will find our complete product range at:  
[phoenixcontact.com](http://phoenixcontact.com)

PHOENIX CONTACT GmbH & Co. KG  
Flachmarktstraße 8  
32825 Blomberg, Germany  
Phone: +49 52 35 3-00  
Fax: +49 52 35 3-4 12 00  
E-mail: [info@phoenixcontact.com](mailto:info@phoenixcontact.com)  
[phoenixcontact.com](http://phoenixcontact.com)